

INTRODUCTION TO ELECTROLYSIS (ELECTROLYTIC CELL)

1. Electrolysis is defined simply as the **decomposition** of a **compound** by an electric current/**electricity**.

A compound that is decomposed by an electric current is called an electrolyte. Some electrolytes are **weak** while others are **strong**.

2. Strong electrolytes are those that are fully ionized/dissociated into (many) ions.

Common strong electrolytes include:

- (i) all **mineral** acids
- (ii) all strong **alkalis**/sodium hydroxide/potassium hydroxide.
- (iii) all soluble **salts**

3. Weak electrolytes are those that are partially/partly ionized/dissociated into (few) ions.

Common weak electrolytes include:

- (i) all **organic** acids
- (ii) all **bases** except sodium hydroxide/potassium hydroxide.
- (iii) **Water**

4. A compound that is **not** decomposed by an electric current is called non-electrolyte.

Non-electrolytes are those compounds /substances that exist as molecules and thus cannot ionize/dissociate into (any) ions .

Common non-electrolytes include:

- (i) most organic solvents (e.g. petrol/paraffin/benzene/methylbenzene/ethanol)
- (ii) all hydrocarbons(alkanes /alkenes/alkynes)
- (iii) Chemicals of life(e.g. proteins, carbohydrates, lipids, starch, sugar)

5. An electrolytes in **solid** state have **fused** /joined ions and therefore do **not** conduct electricity but the **ions** (cations and anions) are **free** and **mobile** in **molten** and **aqueous** (solution, dissolved in water) state.

6. During electrolysis, the free ions are attracted to the **electrodes**.

An electrode is a rod through which current enter and leave the electrolyte during electrolysis.

An electrode that does not influence/alter the products of electrolysis is called an **inert electrode**.

Common inert electrodes include:

(i) **Platinum**

(ii) **Carbon graphite**

Platinum is not usually used in a school laboratory because it is very **expensive**.

Carbon graphite is **easily**/readily and **cheaply** available (from used dry cells).

7. The **positive** electrode is called **Anode**. The anode is the electrode through which **current enter** the electrolyte/**electrons leave** the electrolyte

8. The **negative** electrode is called **Cathode**. The cathode is the electrode through which **current leave** the electrolyte / **electrons enter** the electrolyte

9. During the electrolysis, free **anions** are attracted to the **anode** where they **lose** /**donate** electrons to form **neutral** atoms/molecules. i.e.

$M(l) \rightarrow M^+(l) + e$ (for cations from molten electrolytes)

$M(s) \rightarrow M^+(aq) + e$ (for cations from electrolytes in aqueous state / solution / dissolved in water)

The neutral atoms /molecules form the **products** of electrolysis at the anode. This is called **discharge** at anode

10. During electrolysis, free **cations** are attracted to the **cathode** where they **gain** /**accept/acquire** electrons to form **neutral** atoms/molecules.

$X^+(aq) + 2e \rightarrow X(s)$ (for cations from electrolytes in aqueous state / solution / dissolved in water)

$2X^+(l) + 2e \rightarrow X(l)$ (for cations from molten electrolytes)

The neutral atoms /molecules form the **products** of electrolysis at the cathode. This is called **discharge** at cathode.

11. The below set up shows an electrolytic cell.

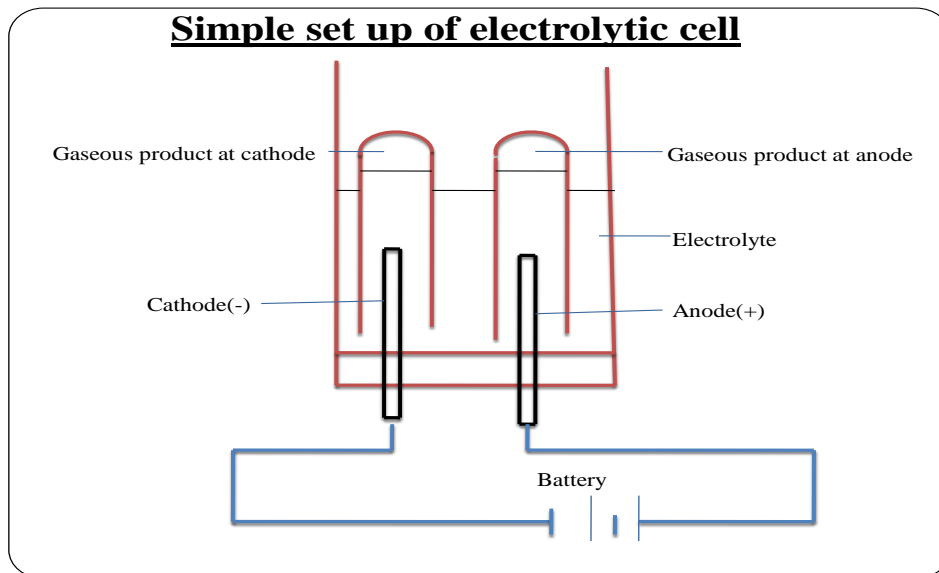

12. For a compound /salt containing only two ion/binary salt the products of electrolysis in an electrolytic cell can be determined as in the below examples:

a) To determine the products of electrolysis of molten Lead(II)chloride

(i) Decomposition of electrolyte into free ions;



(Compound decomposed into free cation and anion in **liquid** state)

(ii) At the cathode/negative electrode(-);

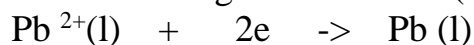

(Cation / Pb^{2+} gains / accepts / acquires electrons to form free **atom**)

(iii) At the anode/positive electrode(+);



(Anion / Cl^{-} donate/lose electrons to form free **atom** then a gas **molecule**)

(iv) Products of electrolysis therefore are;

I. At the cathode grey beads /solid lead metal.

II. At the anode pale green chlorine gas.

b) To determine the products of electrolysis of molten Zinc bromide

(i) Decomposition of electrolyte into free ions;



(Compound decomposed into free cation and anion in **liquid** state)

(ii) At the cathode/negative electrode(-);

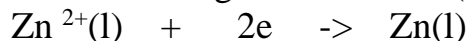

(Cation / Zn^{2+} gains / accepts / acquires electrons to form free **atom**)

(iii) At the anode/positive electrode(+);



(Anion / Br^{-} donate/lose electrons to form free **atom** then a liquid **molecule** which change to **gas** on heating)

(iv) Products of electrolysis therefore are;

I. At the cathode grey beads /solid Zinc metal.

II. At the anode **red** bromine **liquid** / **red/brown** bromine **gas**.

c) To determine the products of electrolysis of molten sodium chloride

(i) Decomposition of electrolyte into free ions;



(Compound decomposed into free cation and anion in **liquid** state)

(ii) At the cathode/negative electrode(-);

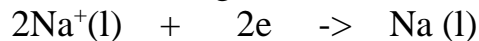

(Cation / Na^{+} gains / accepts / acquires electrons to form free **atom**)

(iii) At the anode/positive electrode(+);



(Anion / Cl^{-} donate/lose electrons to form free **atom** then a gas **molecule**)

(iv) Products of electrolysis therefore are;

I. At the cathode grey beads /solid sodium metal.

II. At the anode pale green chlorine gas.

d) To determine the products of electrolysis of molten Aluminium (III)oxide

(i) Decomposition of electrolyte into free ions;

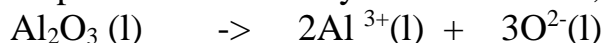

(Compound decomposed into free cation and anion in **liquid** state)

(ii)At the cathode/negative electrode(-);

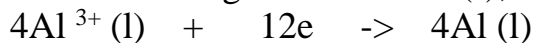

(Cation / Al^{3+} gains / accepts / acquires electrons to form free **atom**)

(iii)At the anode/positive electrode(+);



(Anion / 6O^{2-} donate/lose 12 electrons to form free **atom** then three gas **molecule**)

(iv)Products of electrolysis therefore are;

I.At the cathode grey beads /solid aluminium metal.

II.At the anode colourless gas that relights/rekindles glowing splint.

13.In industries electrolysis has the following uses/applications:

(a)Extraction of reactive metals from their ores.

Potassium, sodium ,magnesium, and aluminium are extracted from their ores using electrolytic methods.

(b)Purifying copper after extraction from copper pyrites ores.

Copper obtained from copper pyrites ores is not pure. After extraction, the copper is refined by electrolysing copper(II)sulphate(VI) solution using the **impure** copper as **anode** and a thin strip of **pure** copper as **cathode**. Electrode ionization take place there:

(i)At the cathode; $\text{Cu}^{2+}(\text{aq}) + 2\text{e}^{-} \rightarrow \text{Cu}(\text{s})$ (Pure copper deposits on the strip)

(ii)At the anode; $\text{Cu}(\text{s}) \rightarrow \text{Cu}^{2+}(\text{aq}) + 2\text{e}^{-}$ (impure copper erodes/dissolves)

(c)Electroplating

The label EPNS(**E**lectro **P**lated **N**ickel **S**ilver) on some steel/metallic utensils mean they are plated/coated with silver and/or Nickel to **improve** their **appearance**(add their **aesthetic** value)and **prevent**/slow **corrosion**(**rusting** of iron). Electroplating is the process of coating a metal with another metal using an electric current.

During electroplating, the **cathode** is made of the metal to be **coated**/impure.

Example:

During the electroplating of a spoon with silver

(i)the spoon/impure is placed as the cathode(negative terminal of battery)

(ii)the pure silver is placed as the anode(positive terminal of battery)

(iii)the pure silver erodes/ionizes/dissociates to release electrons:

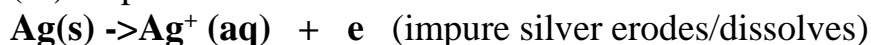

(iv) silver (Ag^+) ions from electrolyte gain electrons to form pure silver deposits / coat / cover the spoon/impure
 $\text{Ag}^+(\text{aq}) + \text{e}^- \rightarrow \text{Ag}(\text{s})$ (pure silver deposits /coat/cover on spoon)

$\text{Ag}(\text{s}) \rightarrow \text{Ag}^+(\text{aq}) + \text{e}^-$ (pure silver erodes/dissolves)

(iv) silver (Ag^+) ions from electrolyte gain electrons to form pure silver deposits / coat /cover the spoon/impure

$\text{Ag}^+(\text{aq}) + \text{e}^- \rightarrow \text{Ag}(\text{s})$ (pure silver deposits /coat/cover on spoon)

Electrolytic set up during electroplating

